

Cycloid

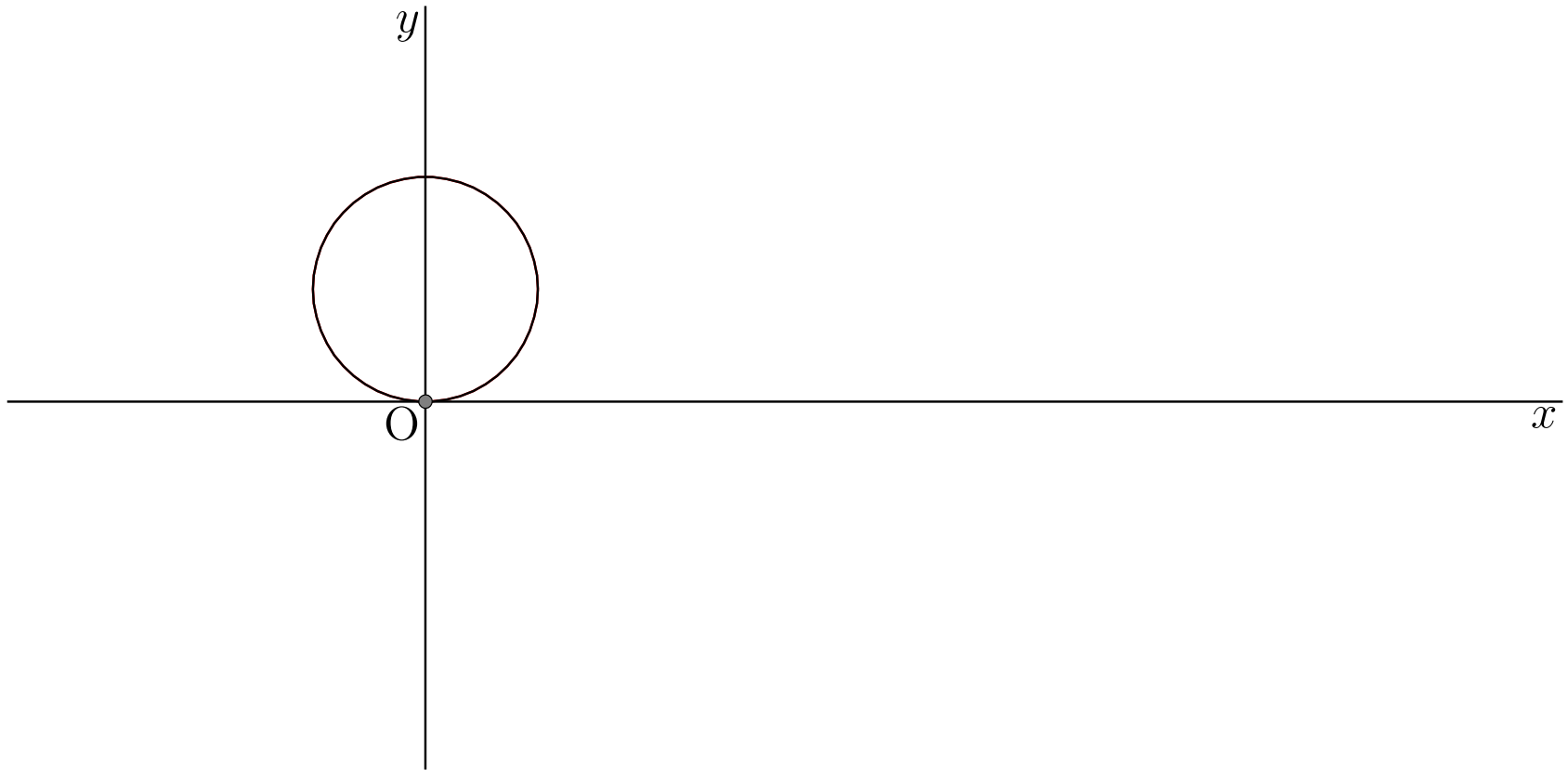

Cycloid

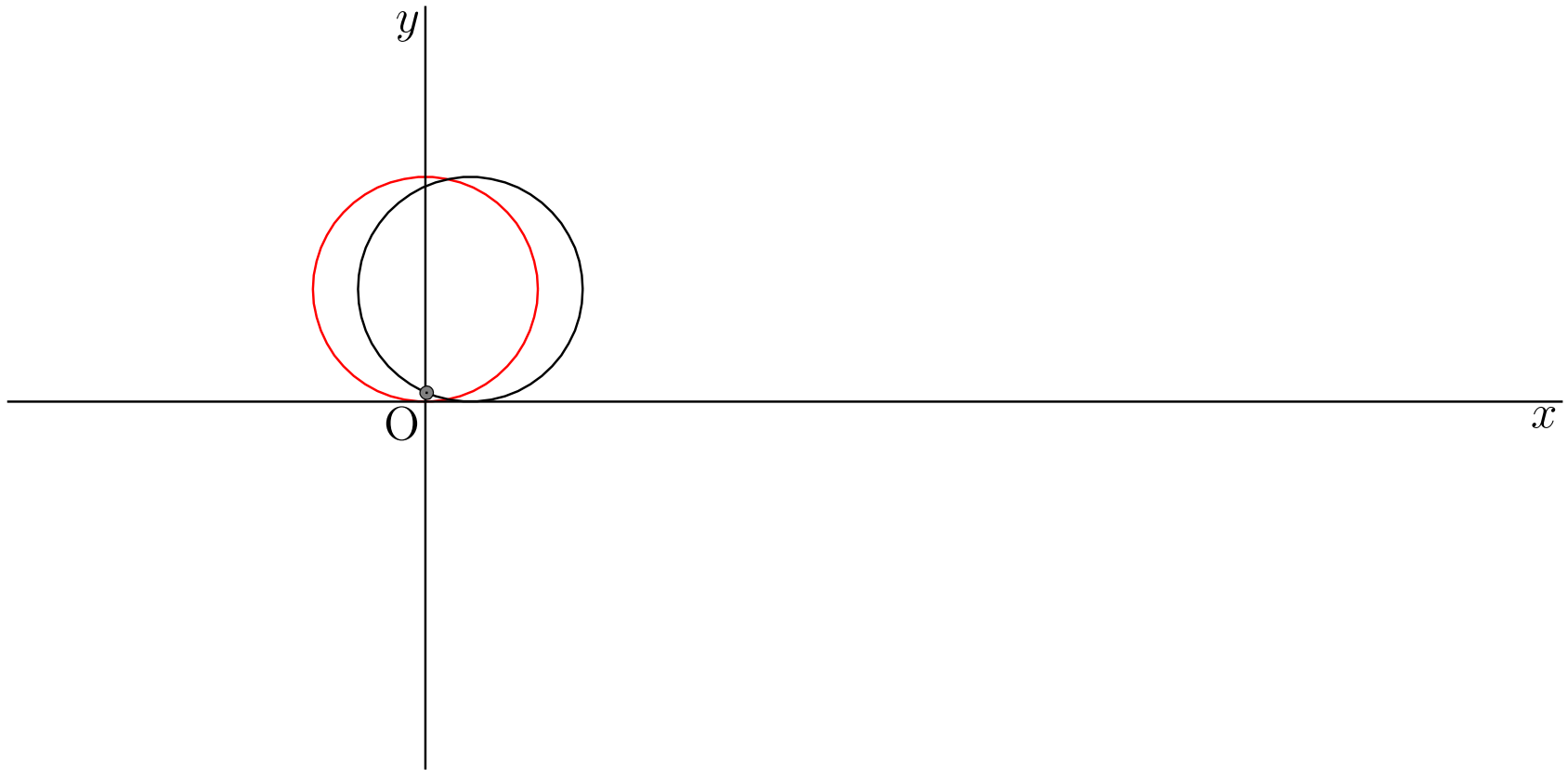

Cycloid

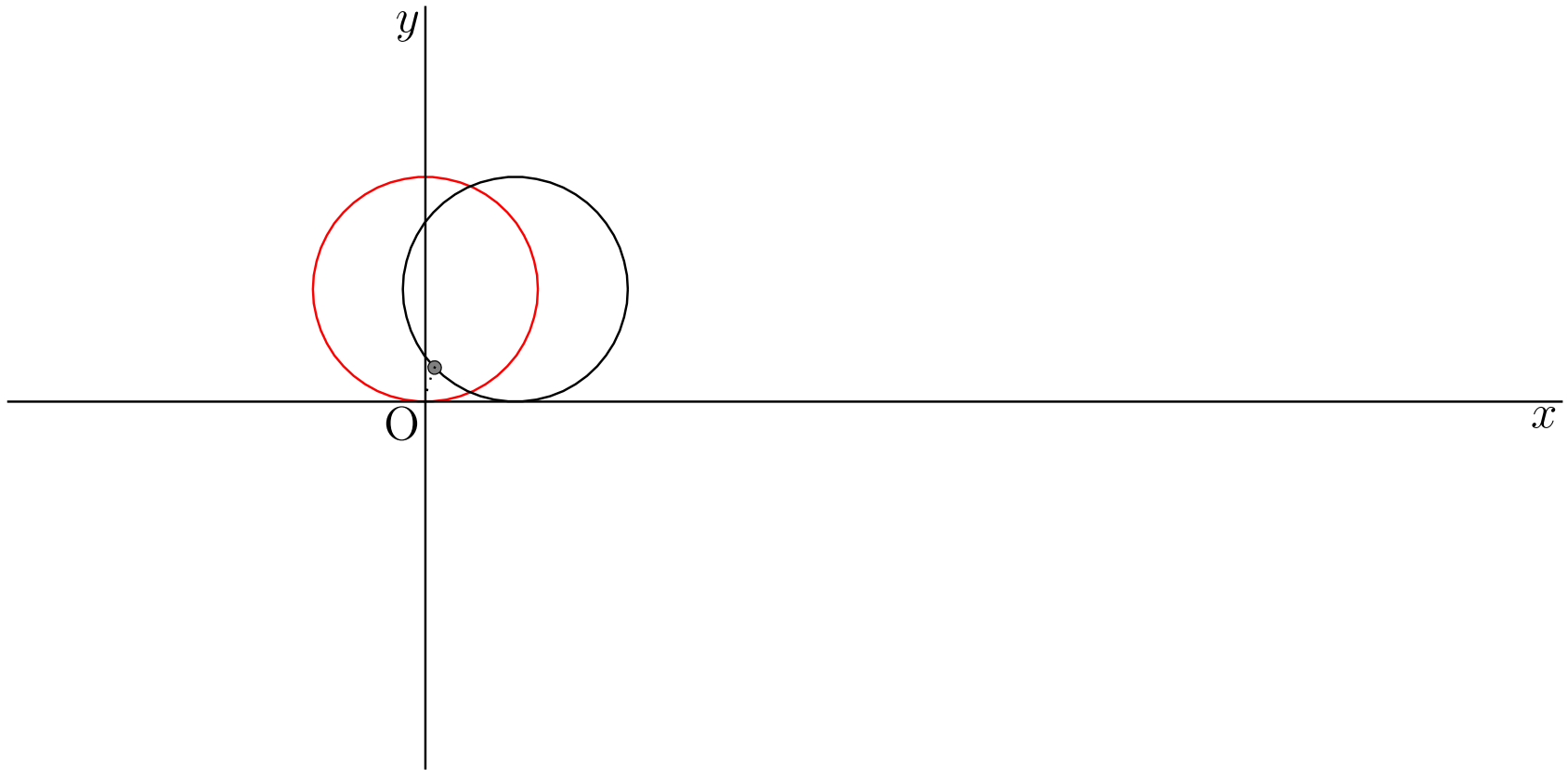

Cycloid

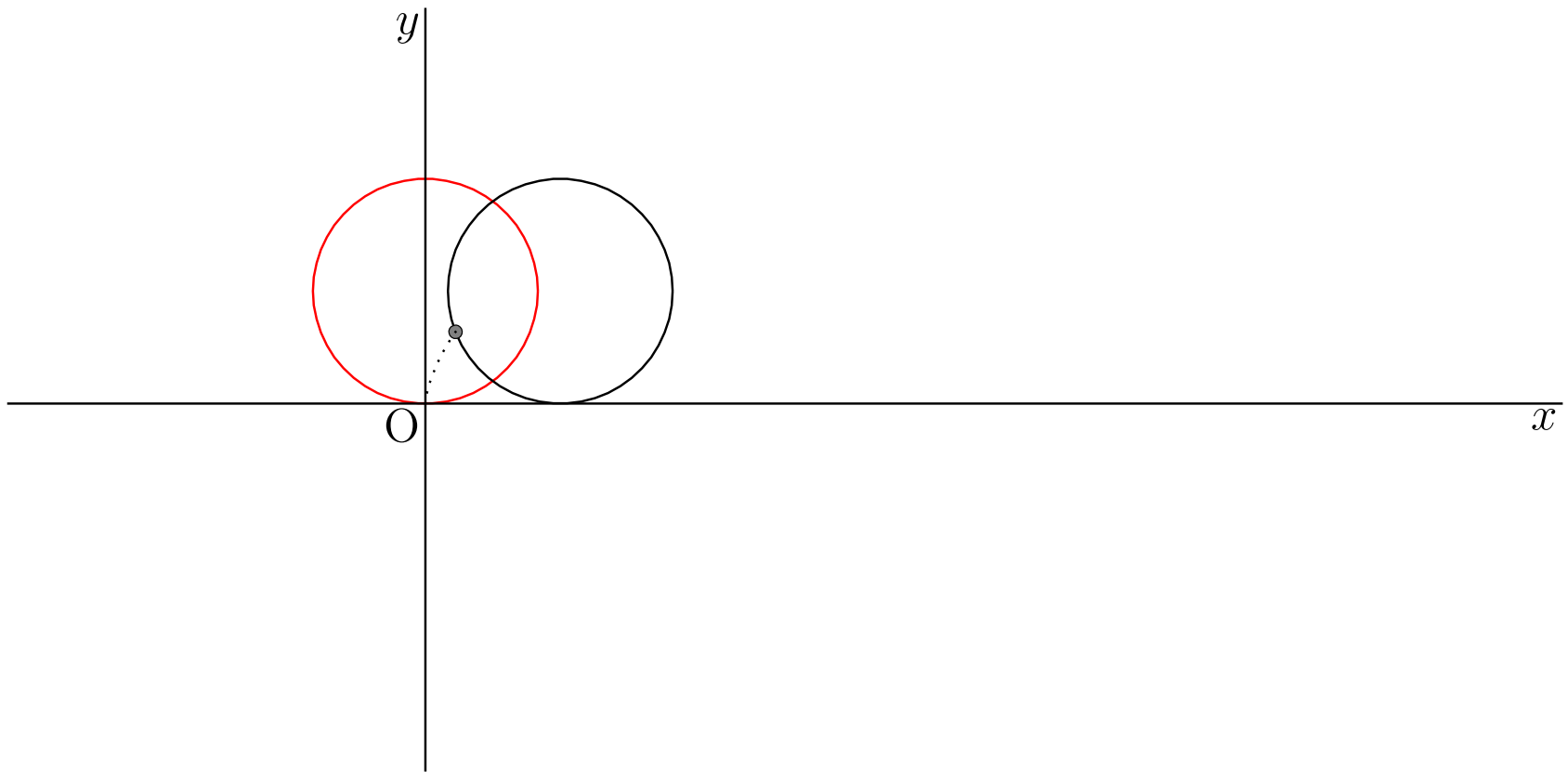

Cycloid

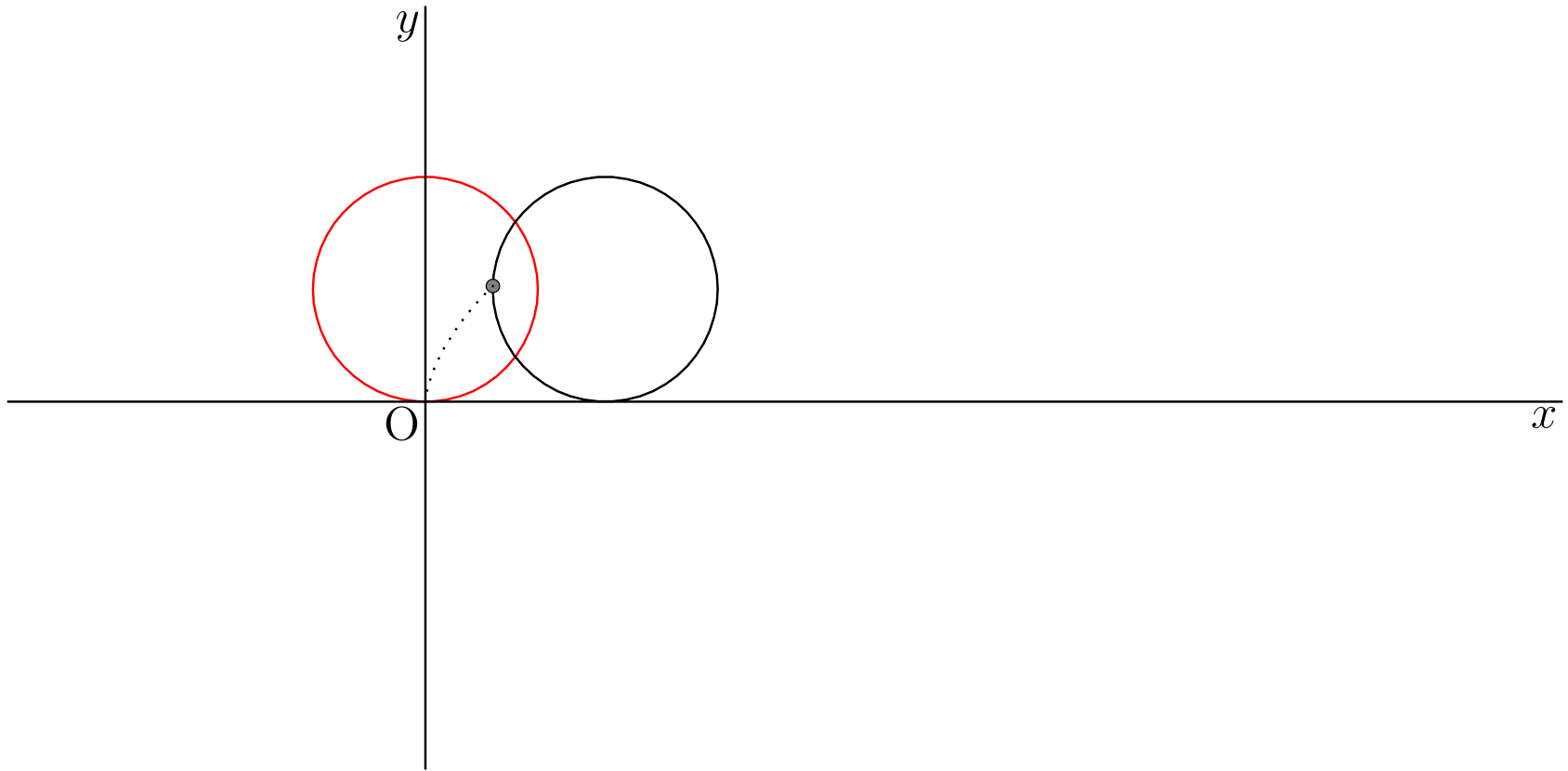

Cycloid

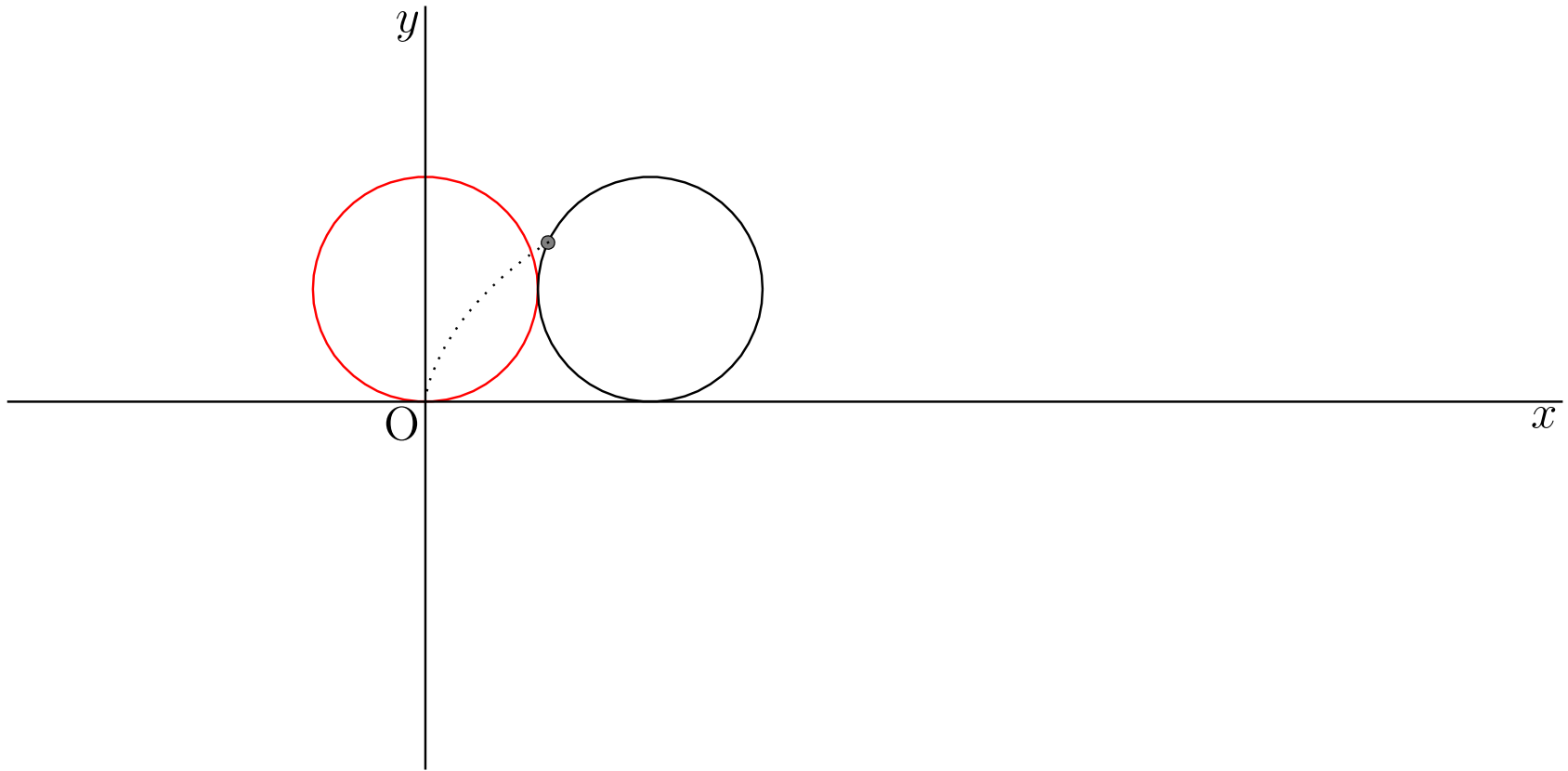

Cycloid

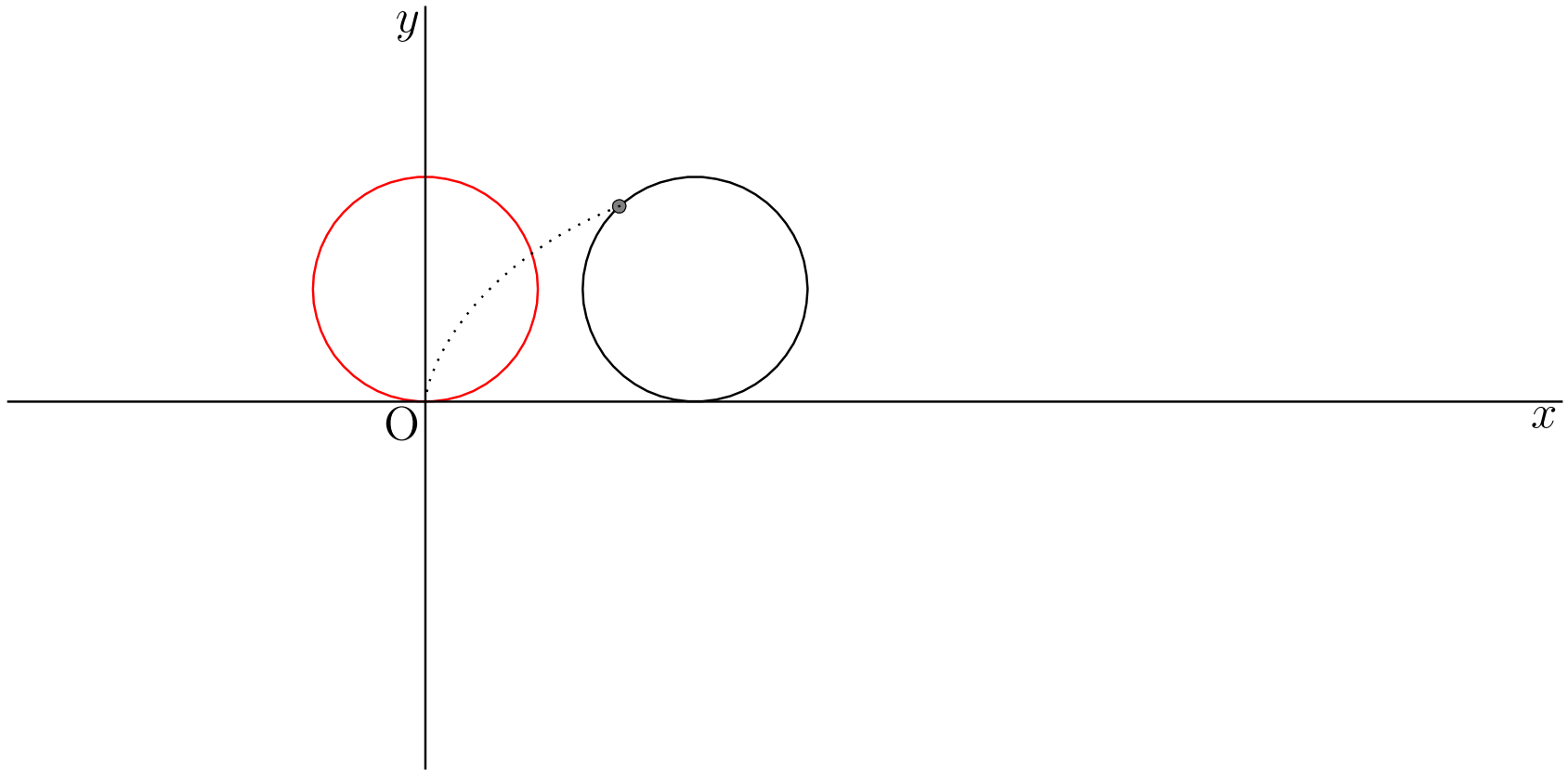

Cycloid

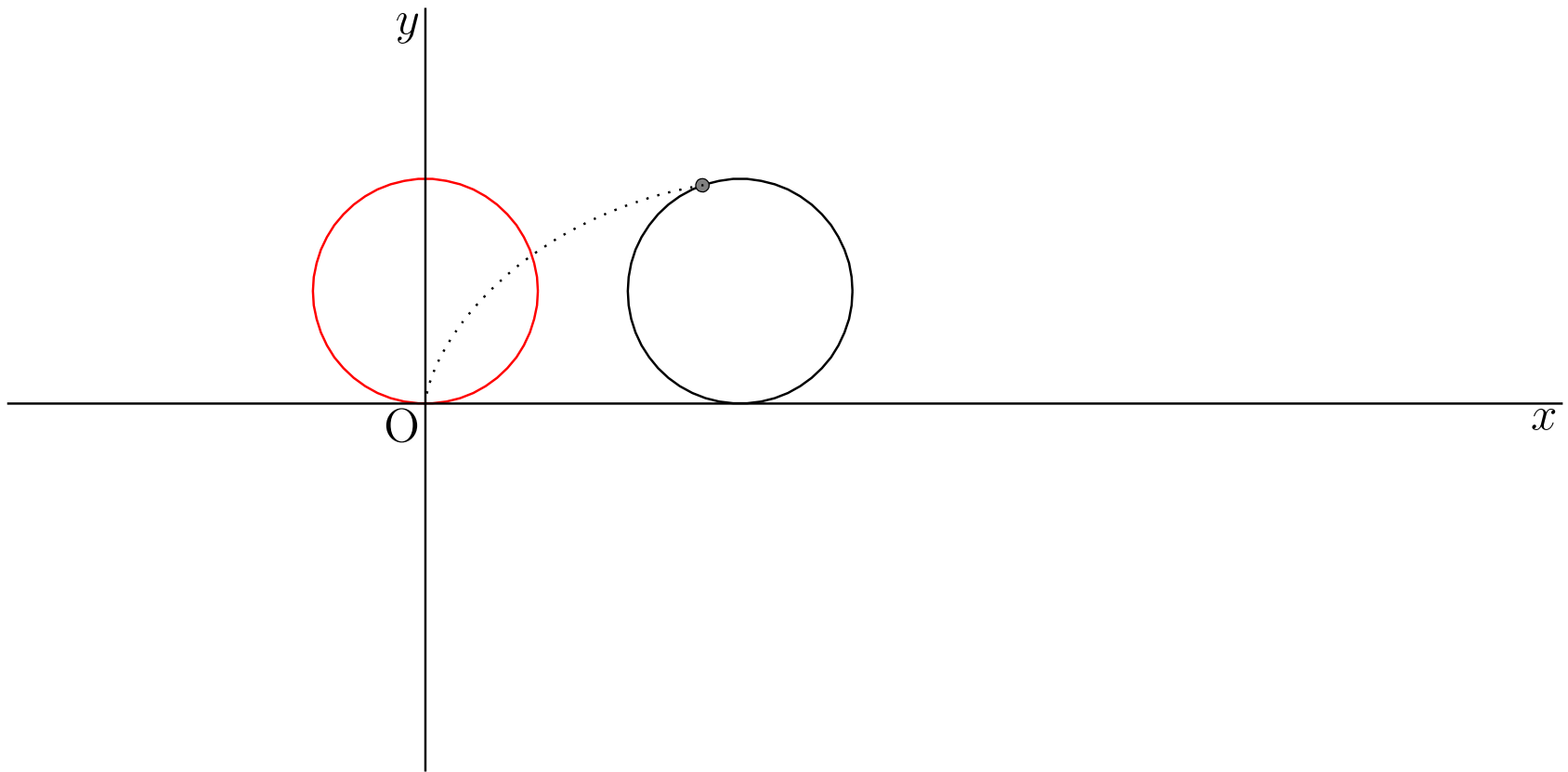

Cycloid

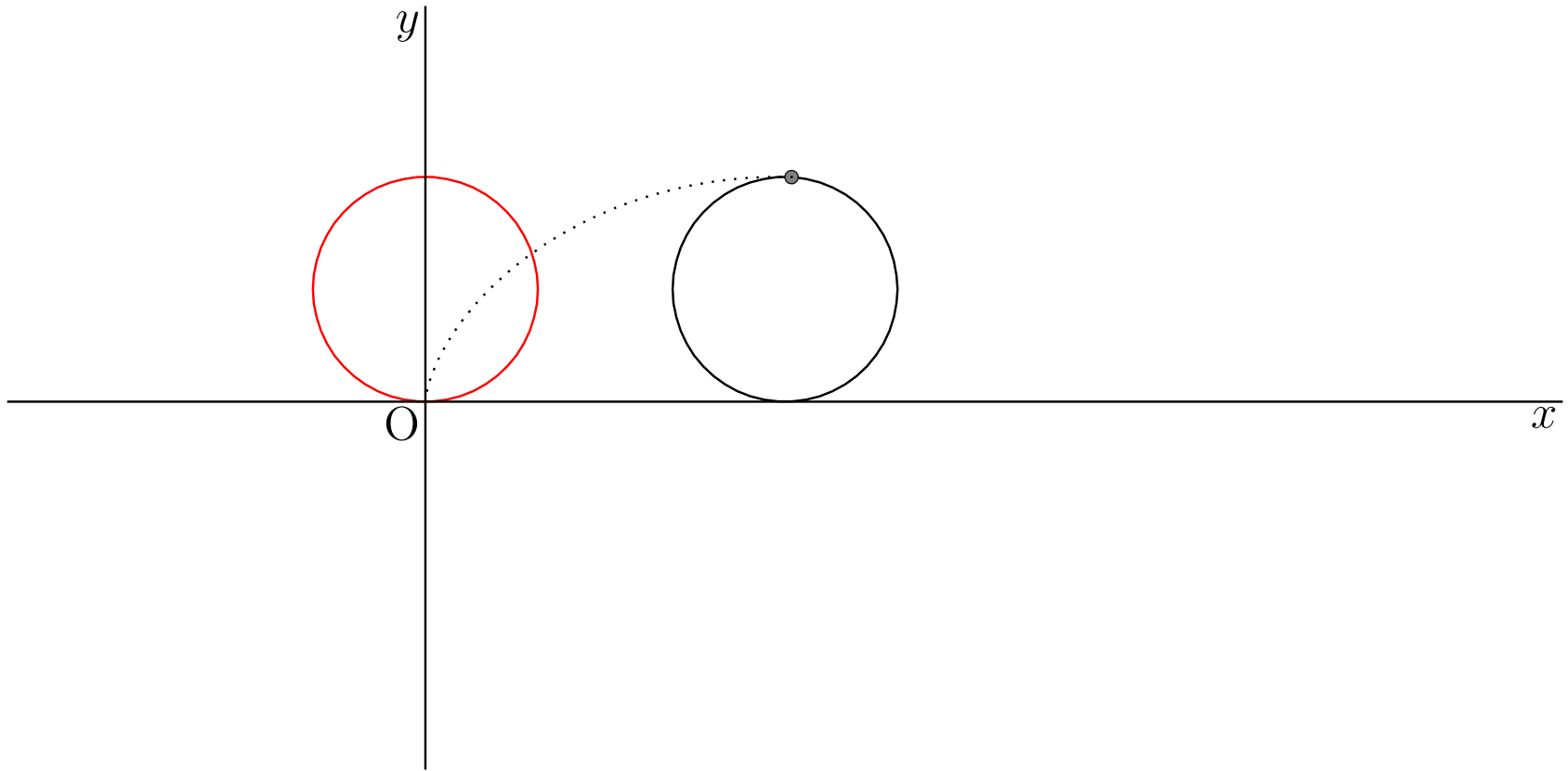

Cycloid

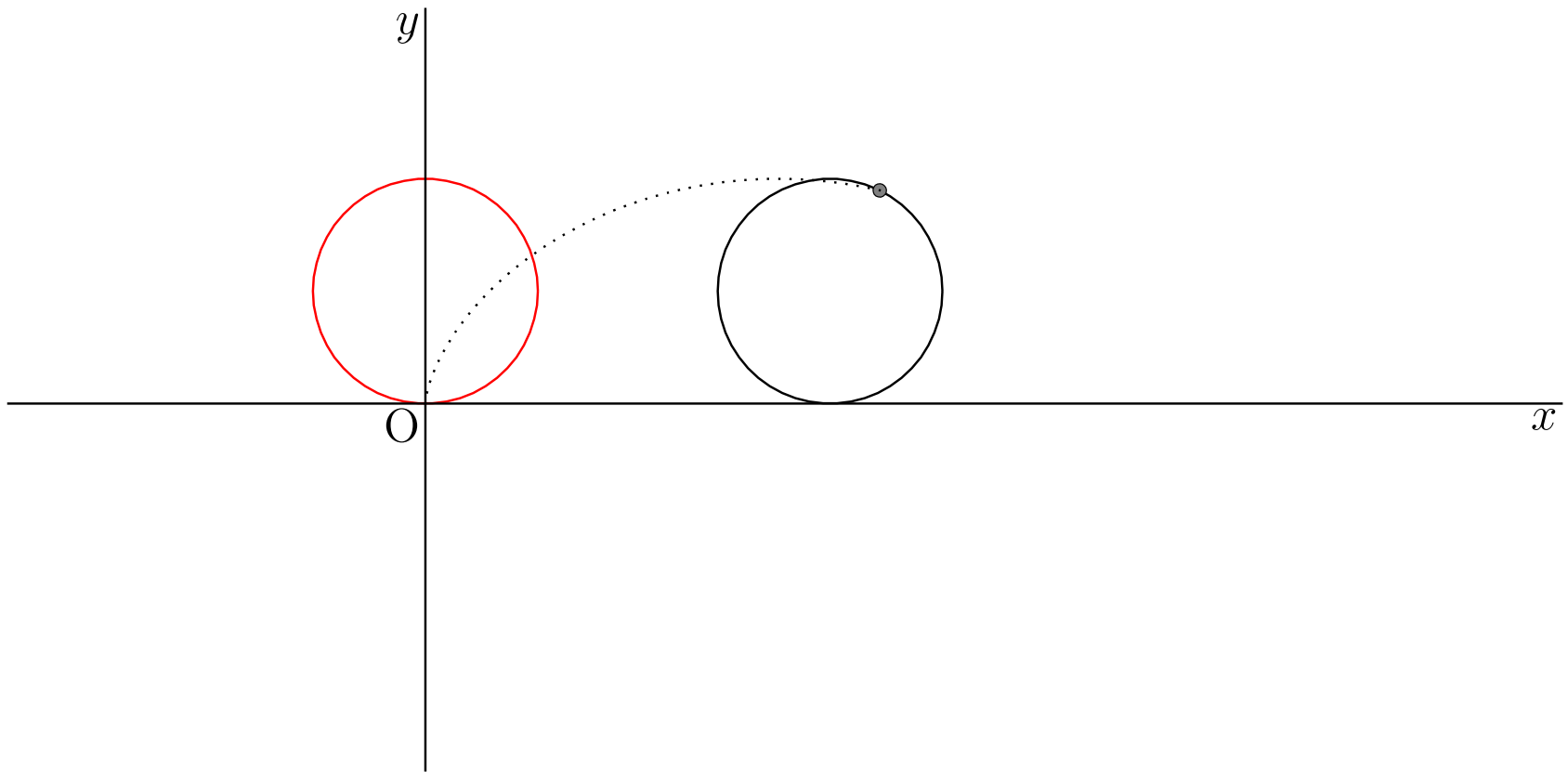

Cycloid

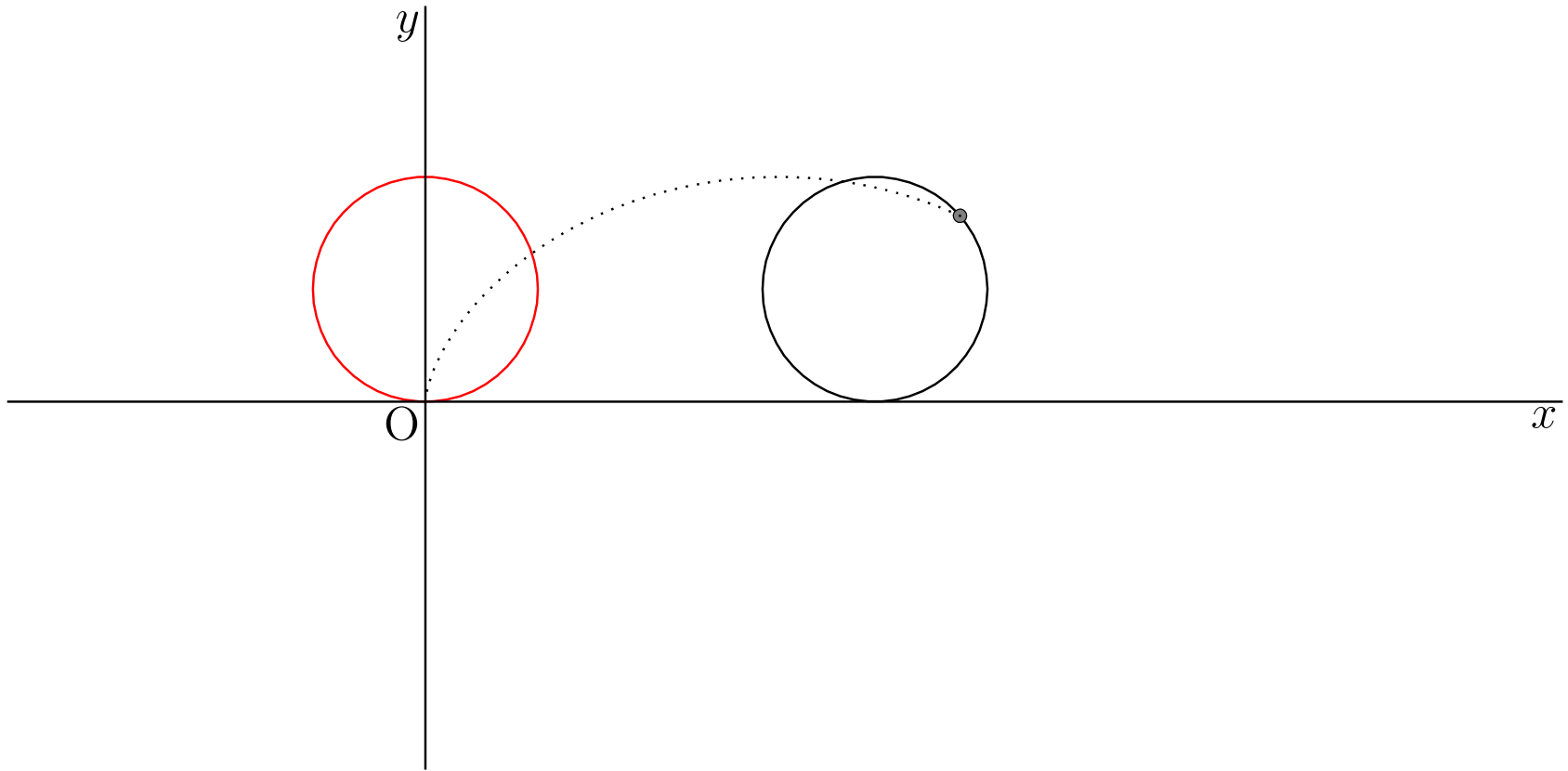

Cycloid

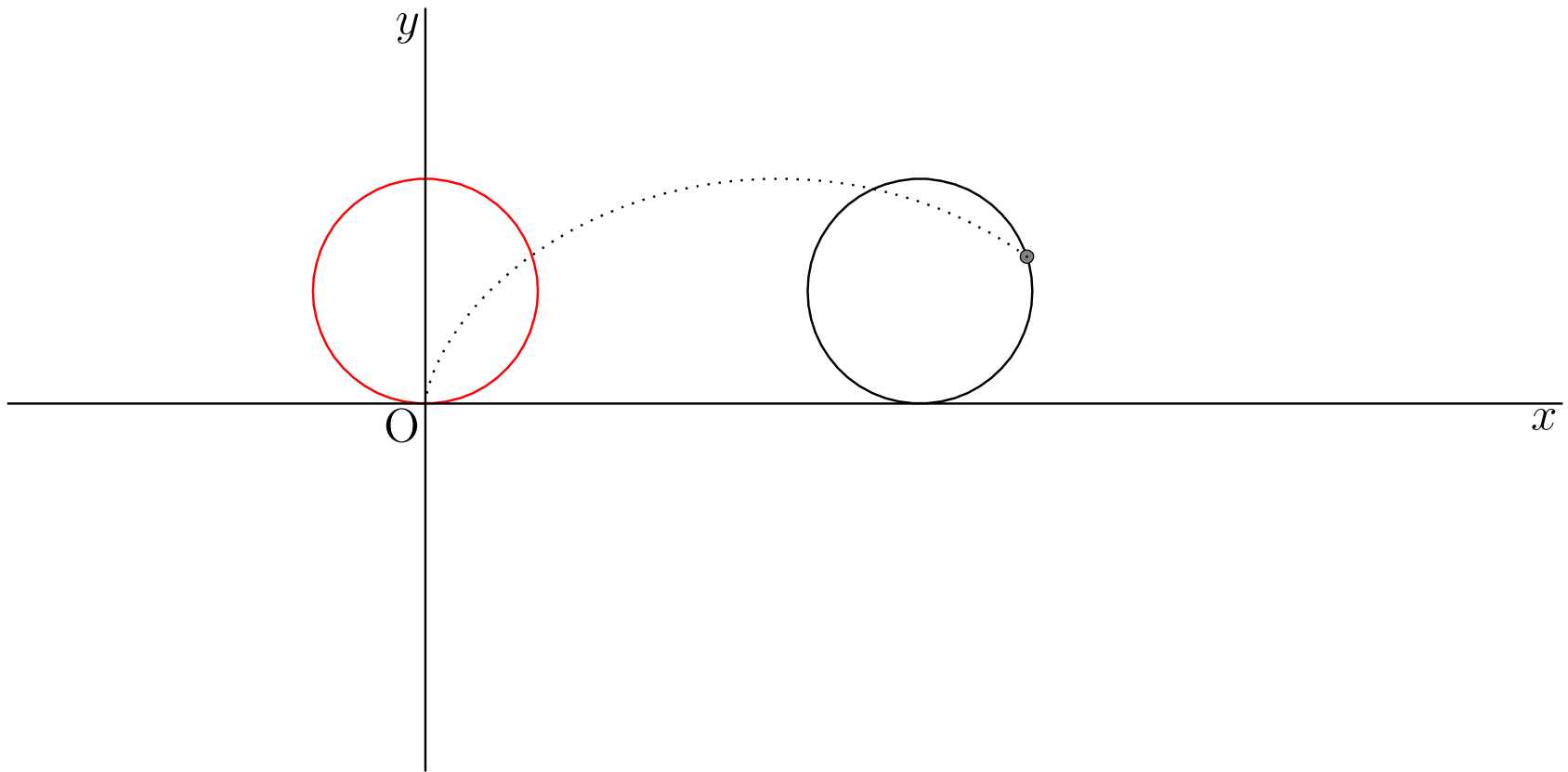

Cycloid

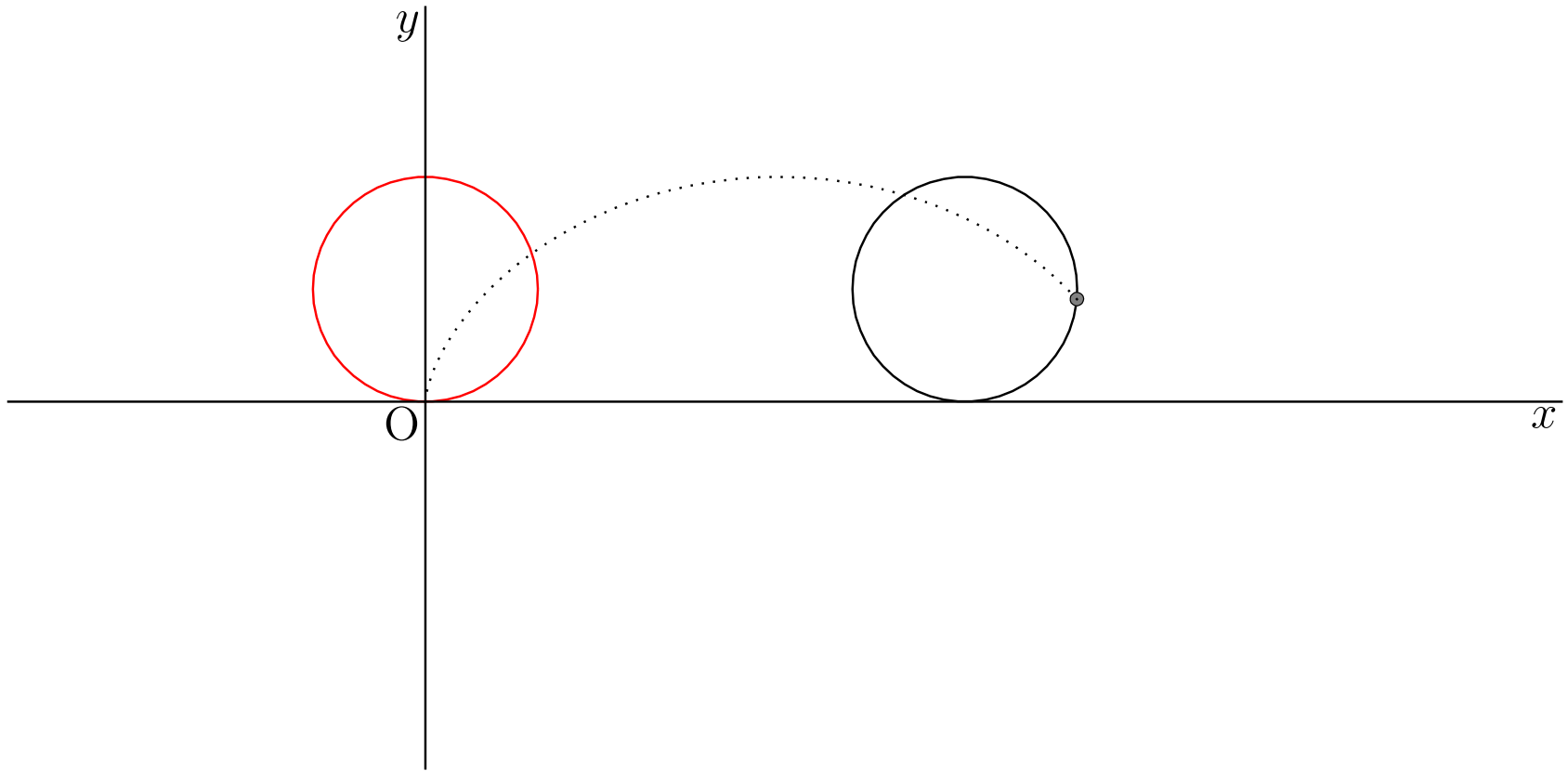

Cycloid

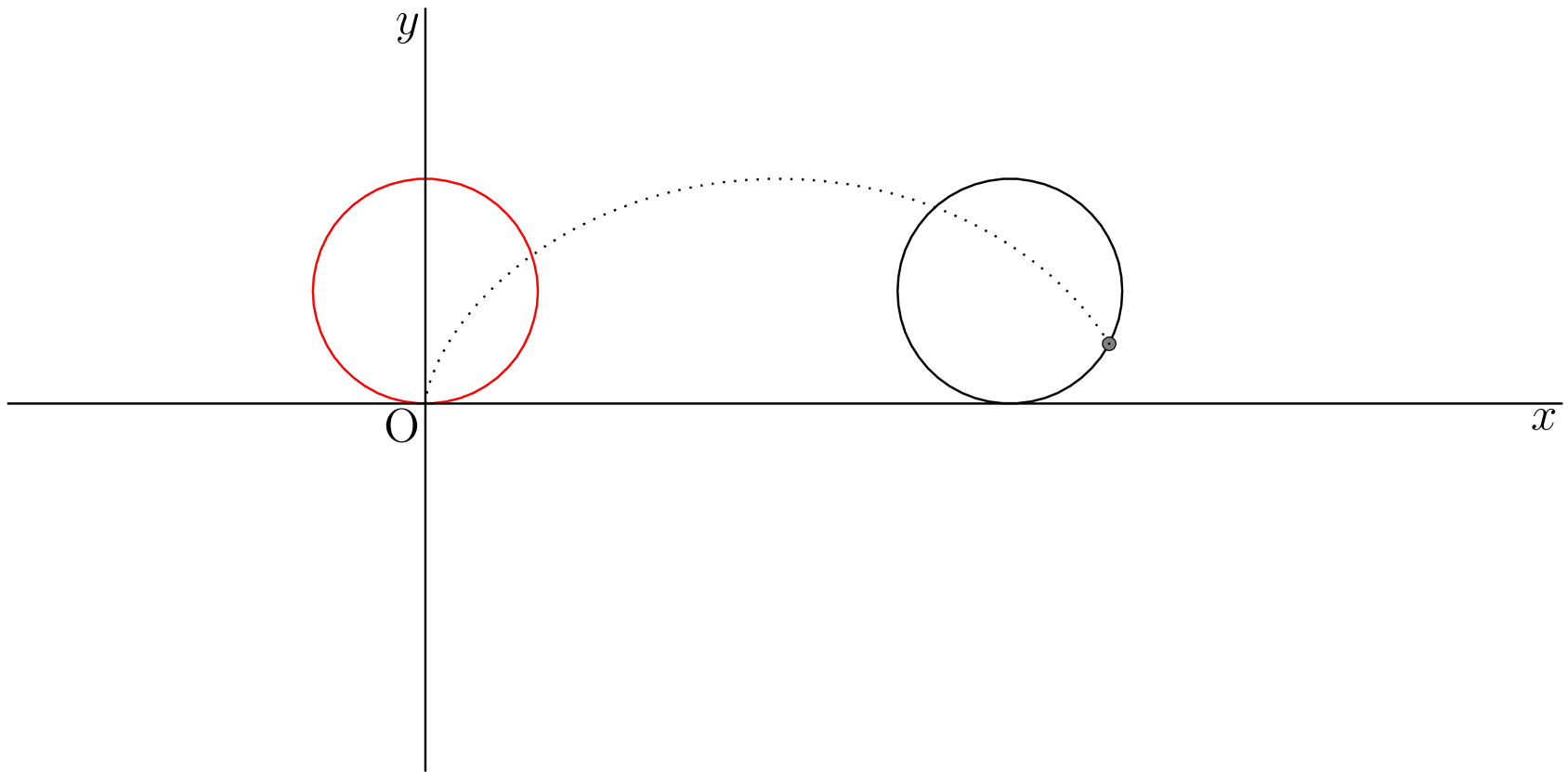

Cycloid

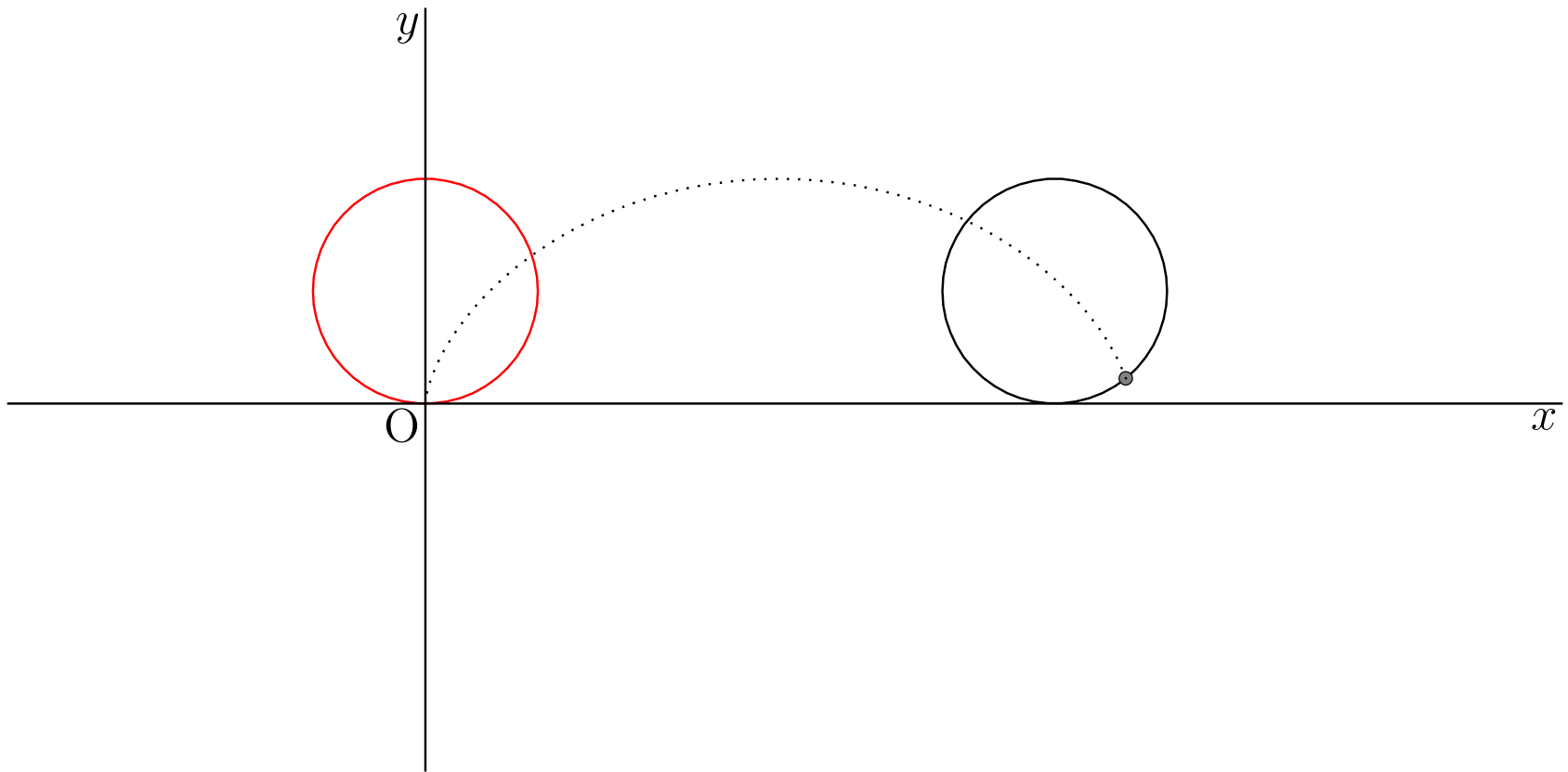

Cycloid

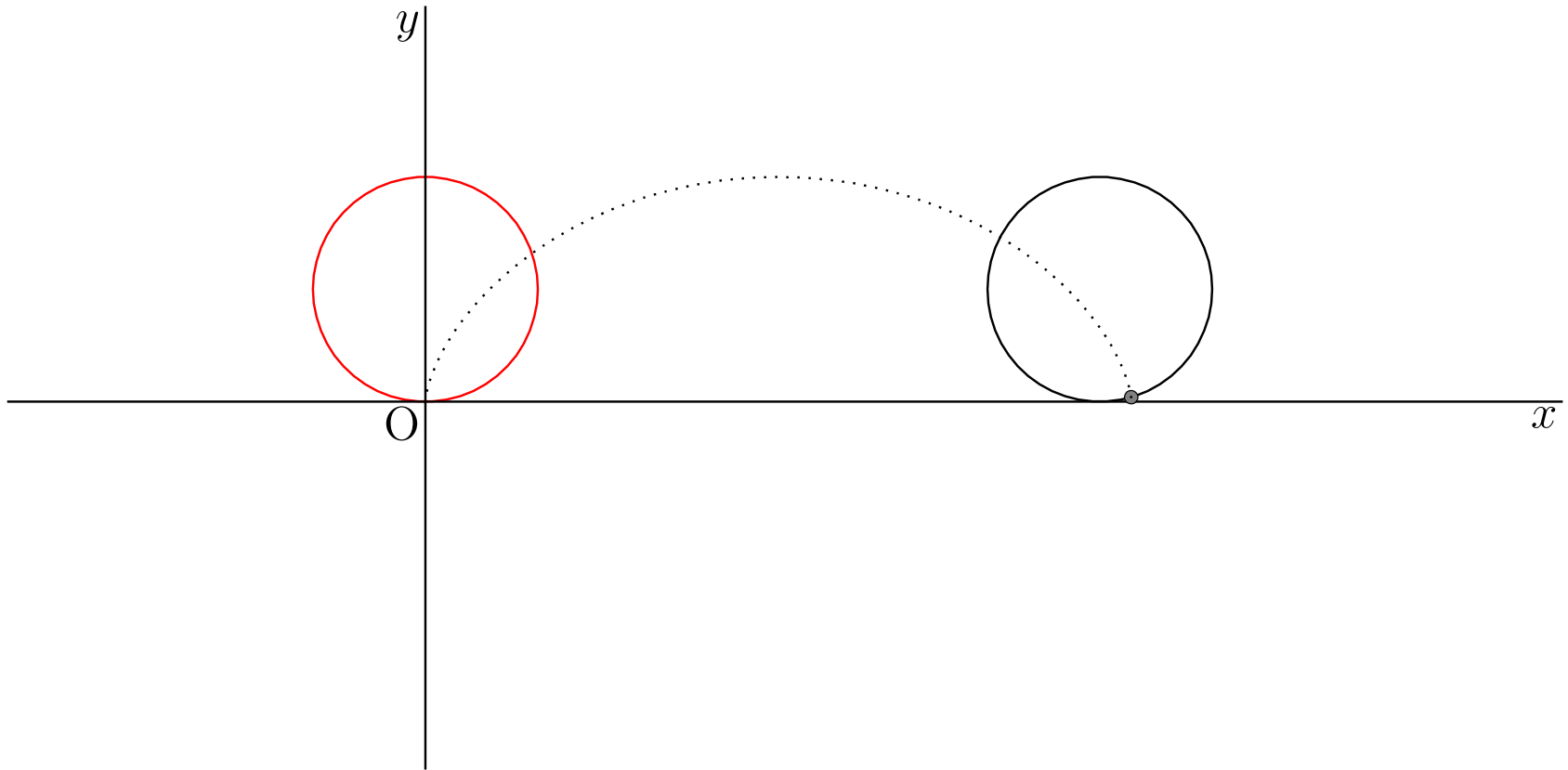

Cycloid

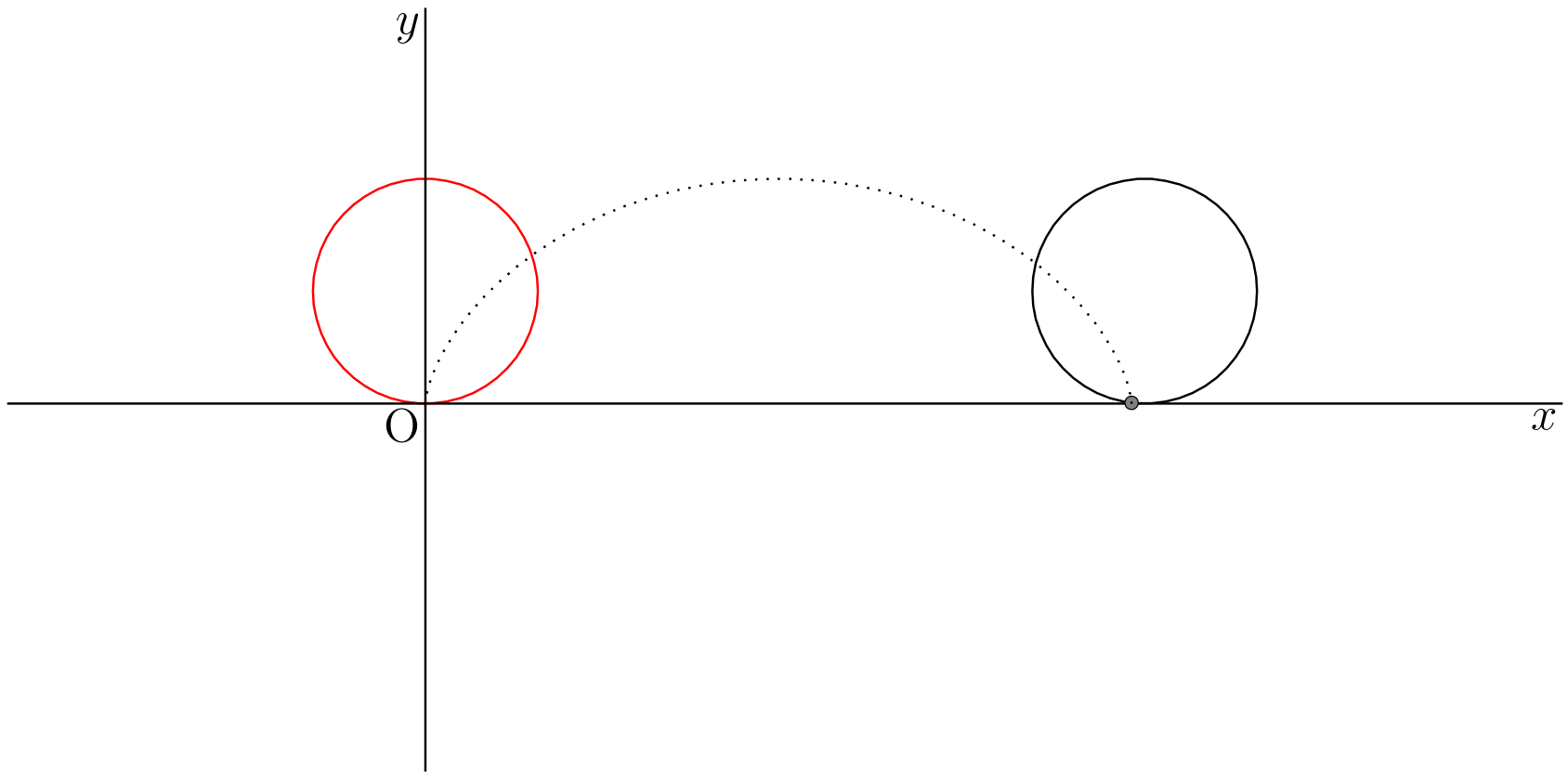

Cycloid

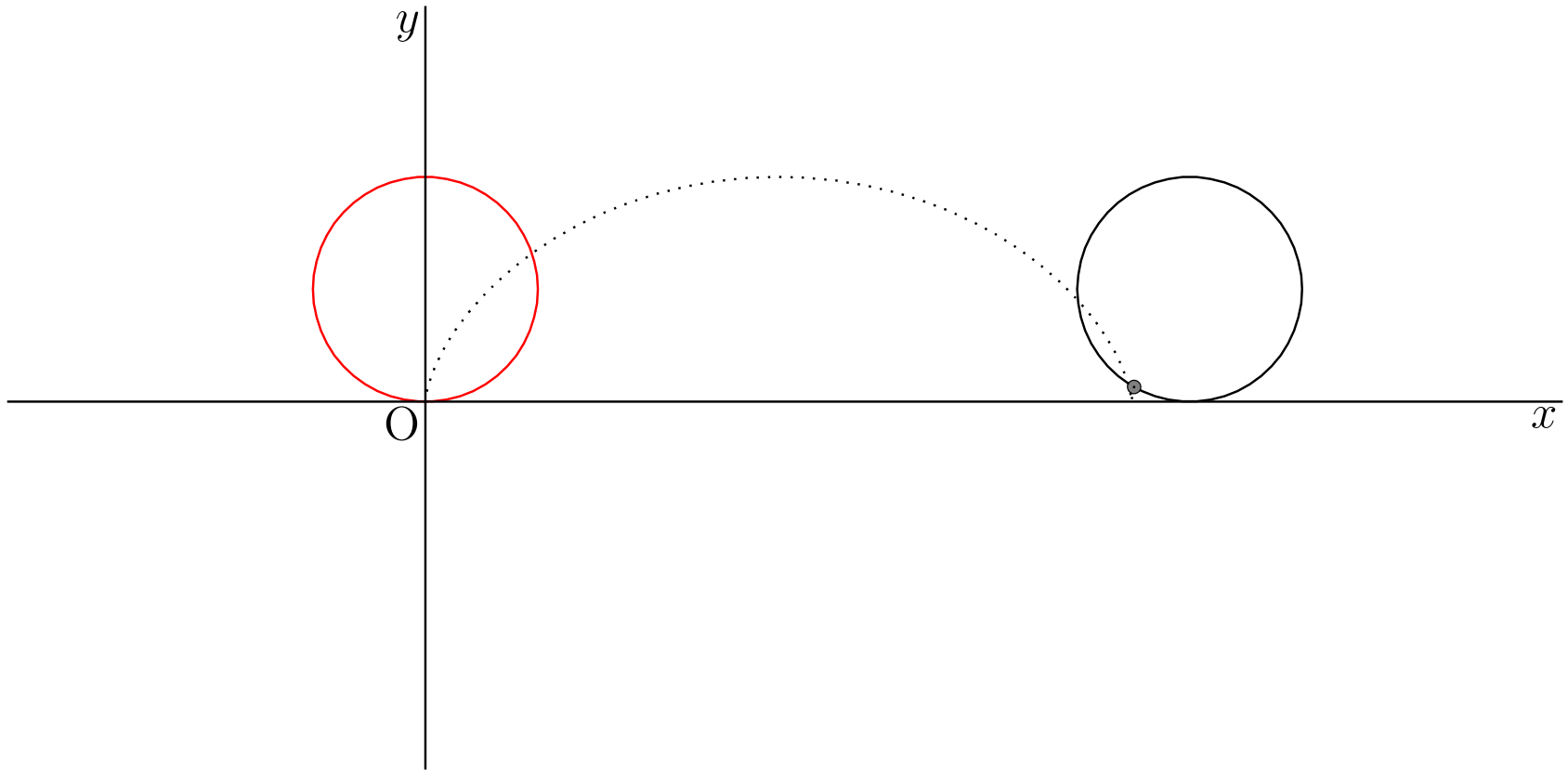

Cycloid

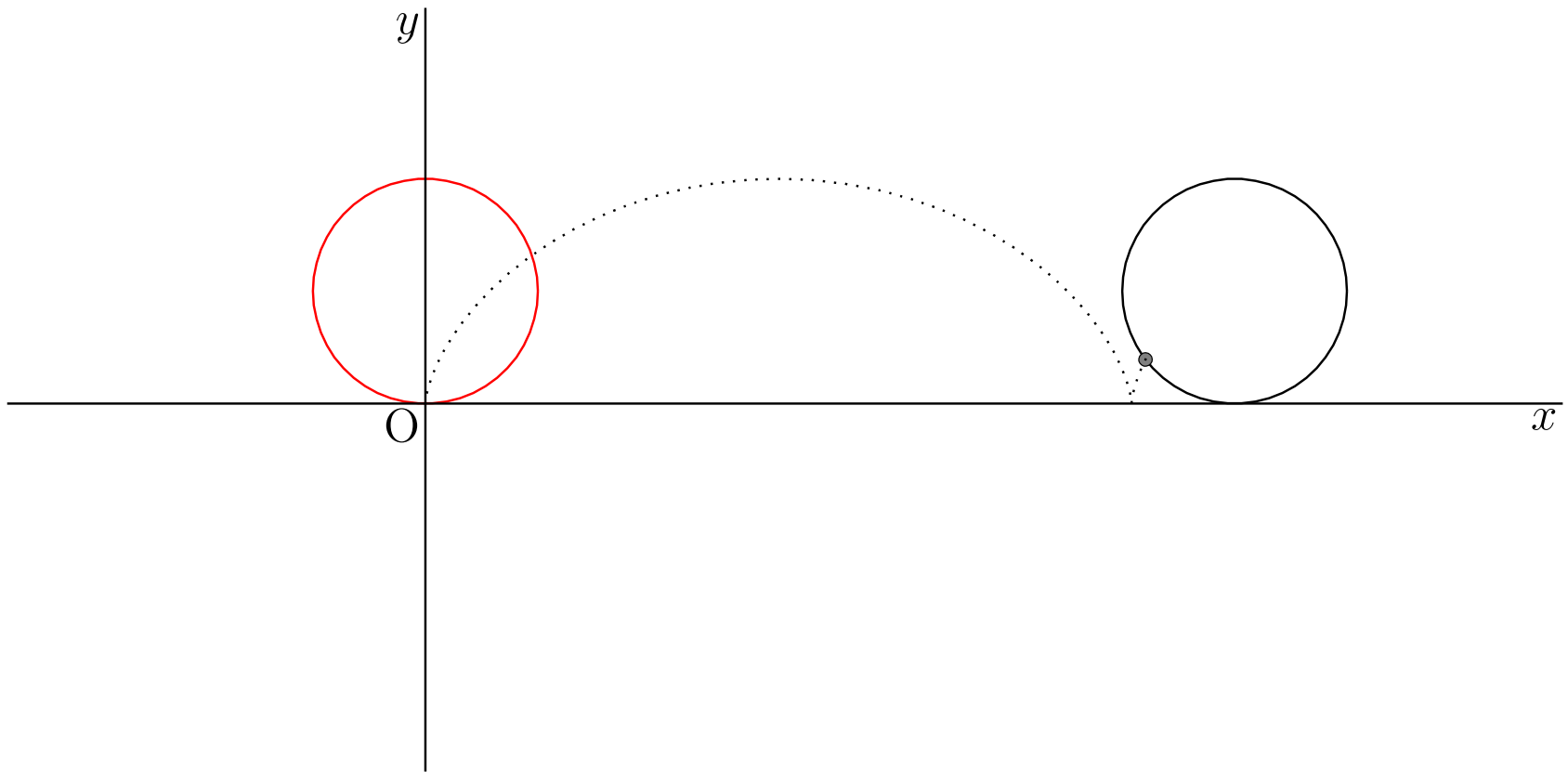

Cycloid

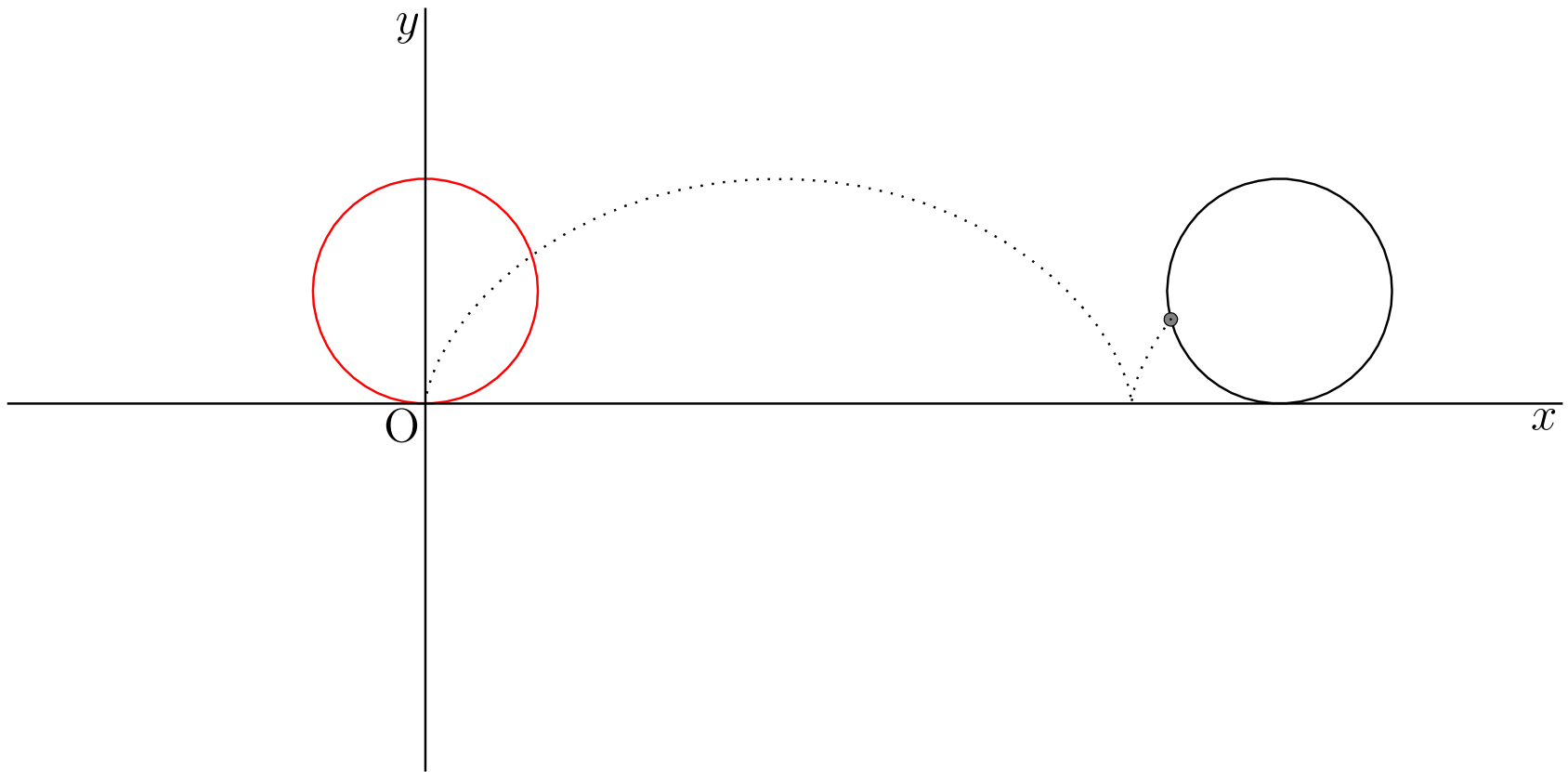

Cycloid

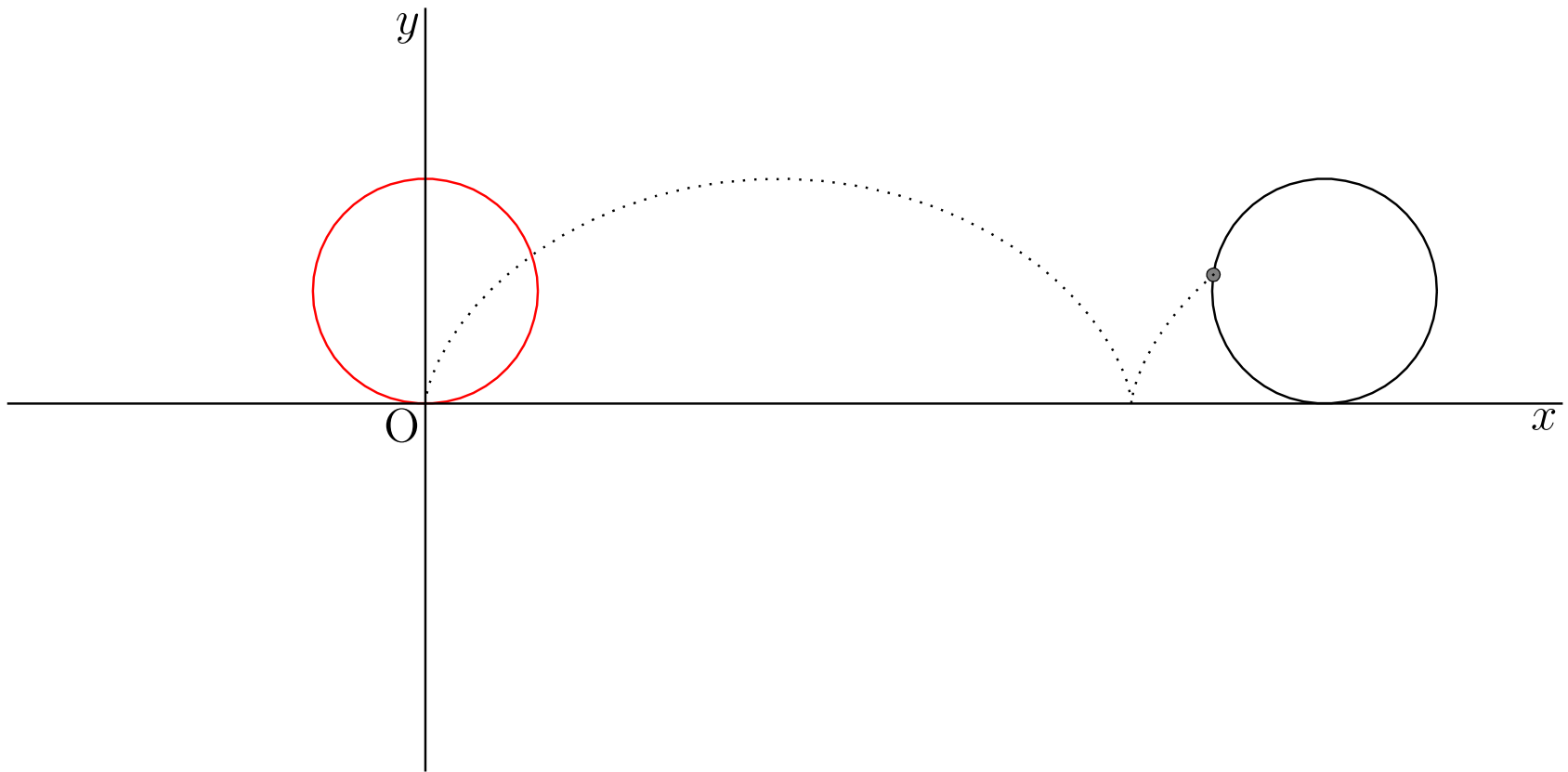

Cycloid

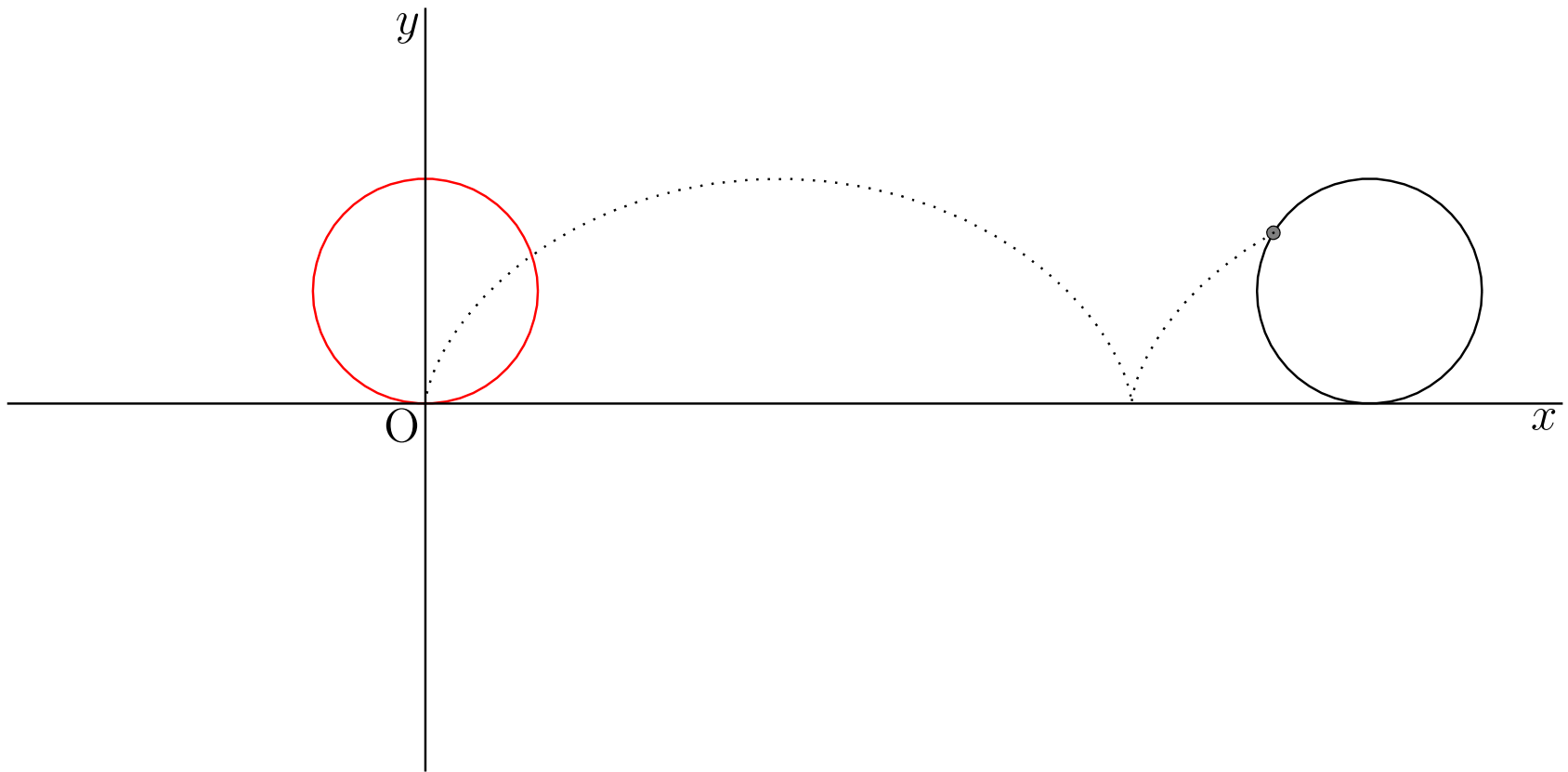

Cycloid

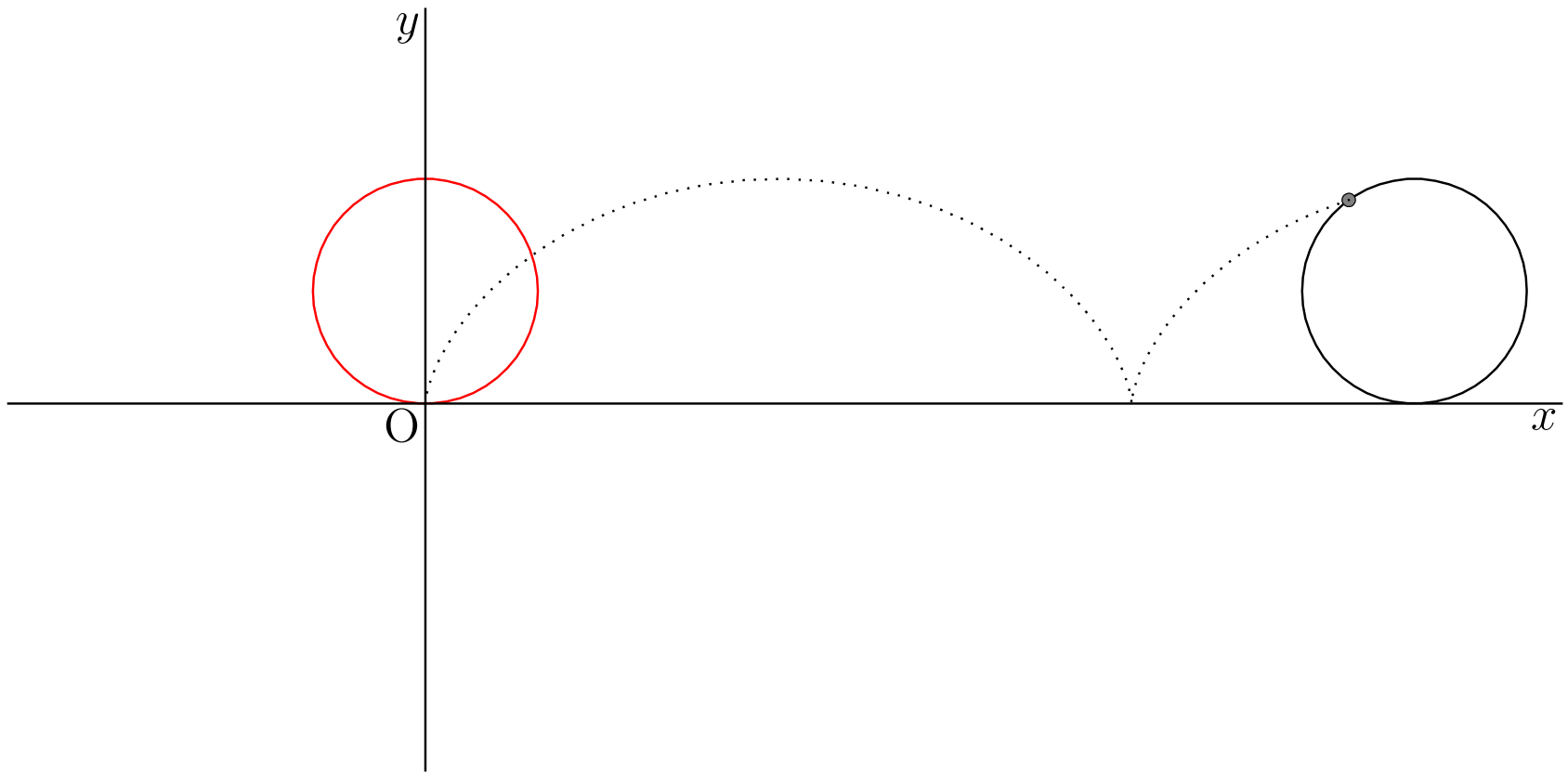

Cycloid

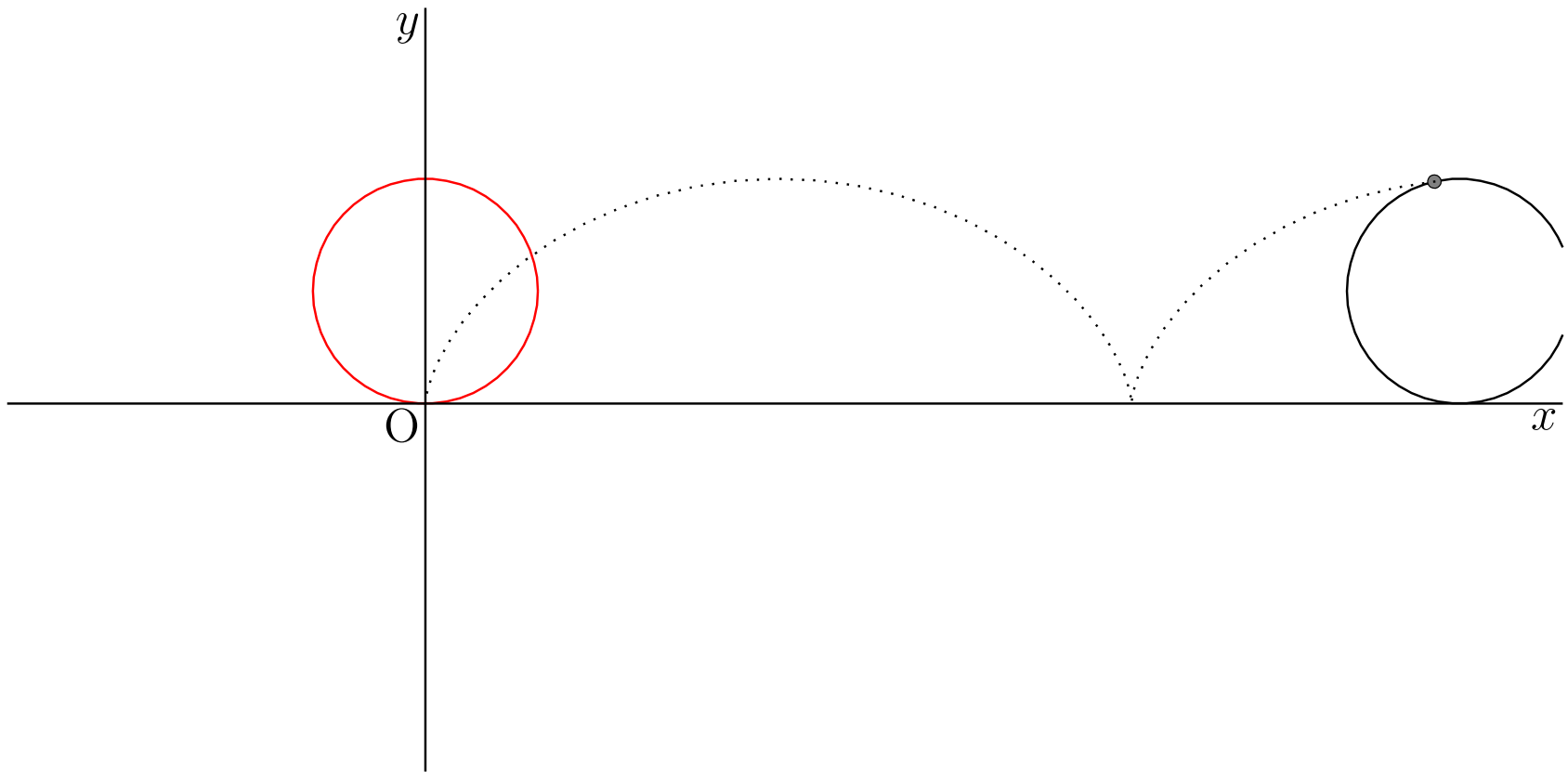

Cycloid

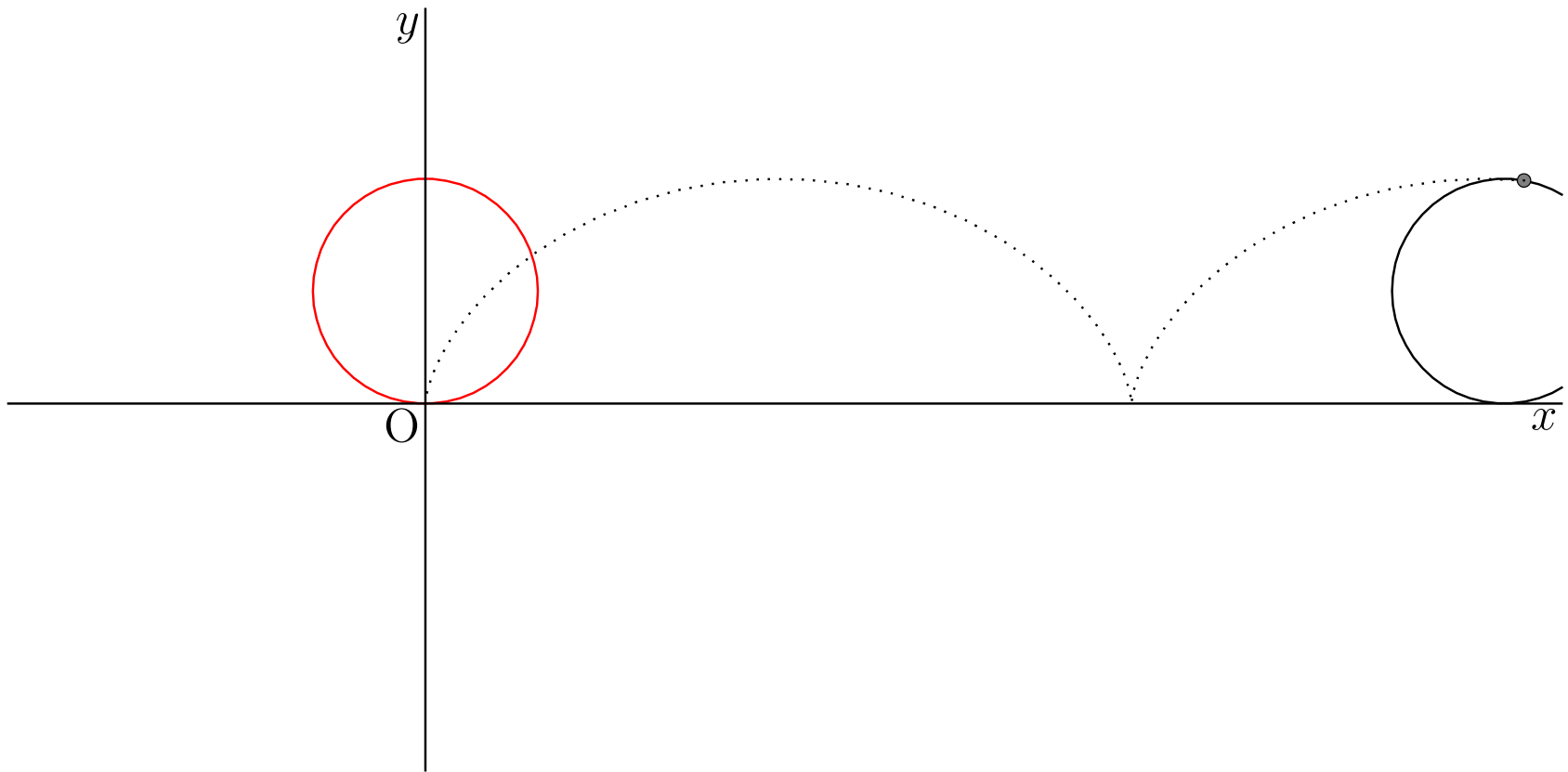

Cycloid

